

PERMANENT WARNING LINE - SafeT-Zone System

The SafeT-Zone permanent warning line system is a cost effective option when guardrails or other fall protection solutions are not practical. When work does not occur regularly in an area of a facility or roof top, a permanent warning line is a simple solution to help safeguard controlled access to a hazardous location. Not for use as fall arrest or as a horizontal lifeline. Do not use if working closer than 15ft. from a leading edge.

Typical Usage:

Ideal for areas that require roof top fall protection or controlled access zone. Used by employees working on a low slopped roof more than 15ft away from a leading edge.

OSHA Compliance:

OSHA 1926.502

Features:

- Bases conveniently stack with carrying handles.
- 50 lbs, heavy dipped galvanized base plates
- Warning Flags are coated with our long lasting, proprietary protective treatment.
- No drilling or tools needed
- Warning Flags are permanently affixed to a coated cable for OSHA 6ft. spacing compliance.
- 5/32 cable is protected by a safety yellow vinyl coating. Other custom colors are available.
- Warning Flags come with the word "Danger" laser cut into the material for added dissemination.
- Kit comes with 6 galvanized bases, 6 uprights, and 100ft of safety yellow vinyl coated warning line and metal warning flags permanently attached every 6ft.
- Made in the U.S.A.

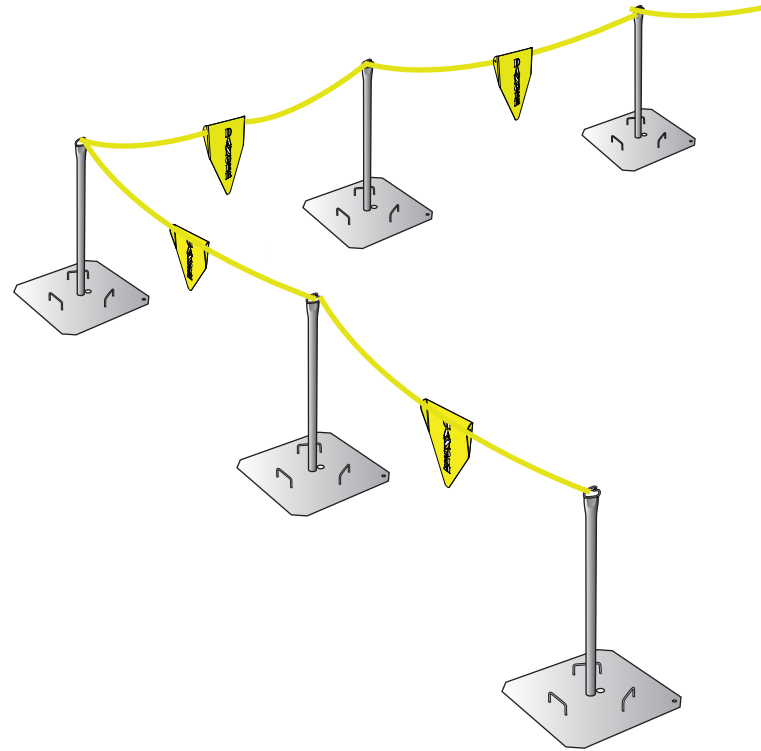

SafeT-Zone Perm Warning Line System Part ID: 65084

Kit comes with 6 galvanized bases and uprights, along with 100ft. of safety yellow vinyl coated cable, and metal warning flags, permanently attached, every 6ft. Each warning flag has "Danger" laser cut into the material.



See reverse side for
additional specifications



OSHA 1926.502 STANDARDS ON PERMANENT WARNING LINE FALL PROTECTION SYSTEMS

1926.502(f)(2)

Warning lines shall consist of ropes, wires, or chains, and supporting stanchions erected as follows: OSHA: A warning line is used 15' or more from the edge.

1926.502(f)(2)(i)

The rope, wire, or chain shall be flagged at not more than 6-foot (1.8 m) intervals with high-visibility material;

1926.502(f)(2)(ii)

The rope, wire, or chain shall be rigged and supported in such a way that its lowest point (including sag) is no less than 34 inches (0.9 m) from the walking/working surface and its highest point is no more than 39 inches (1.0 m) from the walking/working surface;

1926.502(f)(2)(iii)

After being erected, with the rope, wire, or chain attached, stanchions shall be capable of resisting, without tipping over, a force of at least 16 pounds (71 N) applied horizontally against the stanchion, 30 inches (0.8 m) above the walking/working surface, perpendicular to the warning line, and in the direction of the floor, roof, or platform edge;

1926.502(f)(2)(iv)

The rope, wire, or chain shall have a minimum tensile strength of 500 pounds (2.22 kN), and after being attached to the stanchions, shall be capable of supporting, without breaking, the loads applied to the stanchions as prescribed in paragraph (f)(2)(iii) of this section; and

1926.502(f)(2)(v)

The line shall be attached at each stanchion in such a way that pulling on one section of the line between stanchions will not result in slack being taken up in adjacent sections before the stanchion tips over.

1926.502(f)(3)

No employee shall be allowed in the area between a roof edge and a warning line unless the employee is performing roofing work in that area.

1926.502(f)(4)

Mechanical equipment on roofs shall be used or stored only in areas where employees are protected by a warning line system, guardrail system, or personal fall arrest system.

SafeT-Zone Perm Warning Line System #65084

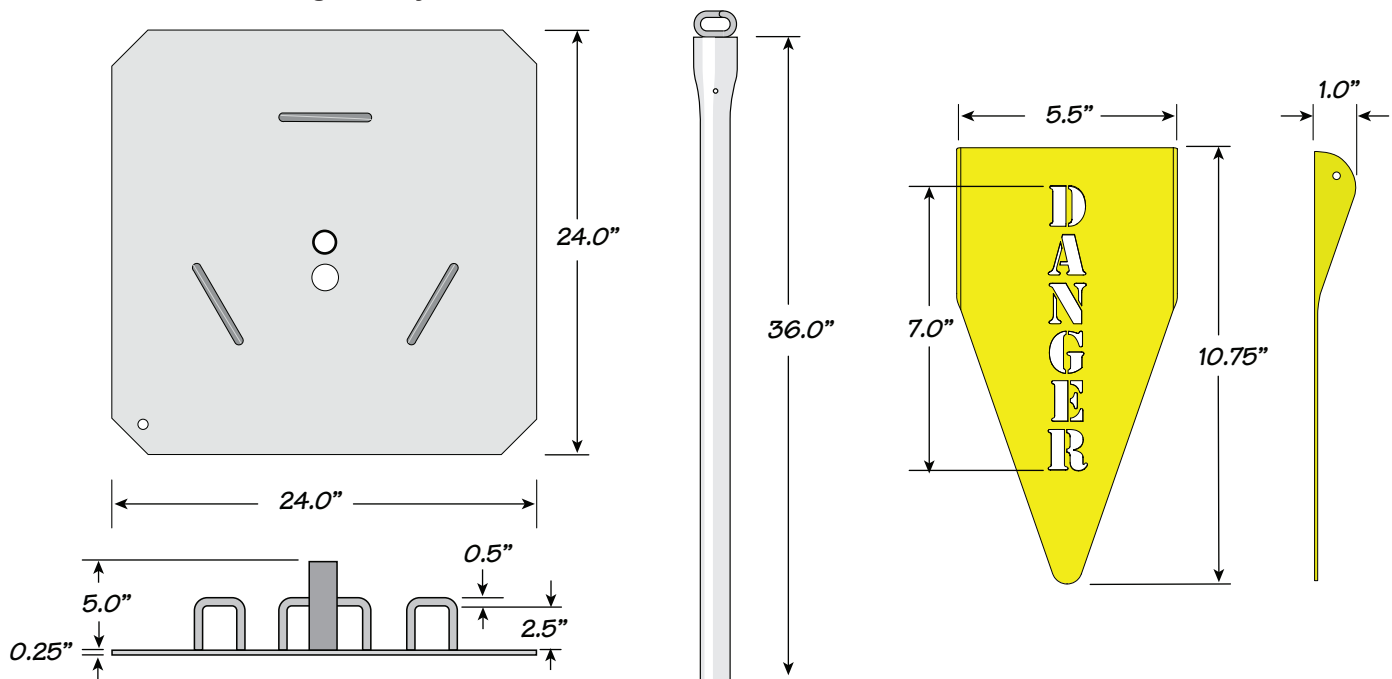

E1580 Rev. 9/26/19